

aerospace
climate control
electromechanical
filtration
fluid & gas handling
hydraulics
pneumatics
process control
sealing & shielding

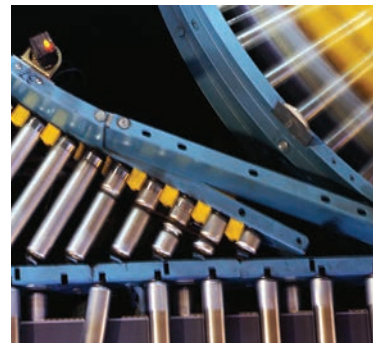

AC10 Variable Speed Drive

IP20 & IP66 Compact Drive for Simple, Reliable Motor Control in General Purpose Applications



ENGINEERING YOUR SUCCESS.



WARNING – USER RESPONSIBILITY

FAILURE OR IMPROPER SELECTION OR IMPROPER USE OF THE PRODUCTS DESCRIBED HEREIN OR RELATED ITEMS CAN CAUSE DEATH, PERSONAL INJURY AND PROPERTY DAMAGE.

- This document and other information from Parker-Hannifin Corporation, its subsidiaries and authorized distributors provide product or system options for further investigation by users having technical expertise.
- The user, through its own analysis and testing, is solely responsible for making the final selection of the system and components and assuring that all performance, endurance, maintenance, safety and warning requirements of the application are met. The user must analyze all aspects of the application, follow applicable industry standards, and follow the information concerning the product in the current product catalog and in any other materials provided from Parker or its subsidiaries or authorized distributors.
- To the extent that Parker or its subsidiaries or authorized distributors provide component or system options based upon data or specifications provided by the user, the user is responsible for determining that such data and specifications are suitable and sufficient for all applications and reasonably foreseeable uses of the components or systems.

Variable Speed Drive - AC10 Series

Overview 5

Technical Characteristics..... 11

- Power Ratings IP20..... 11
- Power Ratings IP66..... 12
- Electrical Characteristics 13
- Environmental Characteristics 13
- Standards and Conformance 13
- Dimensions IP20 - Frames 1-5..... 14
- Dimensions IP20 - Frames 6-11 15
- Dimensions IP66 15
- Connections 16

Accessories and Options 17

- Remote Mounting Keypad..... 17
- Software - Parker Drive Basic (PDB)..... 17
- Clone Module 17
- Braking Resistor 18
- Output Choke 20
- EMC Filter 20

Order Code..... 21

Parker Hannifin

The global leader in motion and control technologies

Global Product Design

Parker Hannifin has more than 40 years experience in the design and manufacturing of drives, controls, motors and mechanical products. With dedicated global product development teams, Parker draws on industry-leading technological leadership and experience from engineering teams in Europe, North America and Asia.

Local Application Expertise

Parker has local engineering resources committed to adapting and applying our current products and technologies to best fit our customers' needs.

Manufacturing to Meet Our Customers' Needs

Parker is committed to meeting the increasing service demands that our customers require to succeed in the global industrial market. Parker's manufacturing teams seek continuous improvement through the implementation of lean manufacturing methods throughout the process. We measure ourselves on meeting our customers' expectations of quality and delivery, not just our own. In order to meet these expectations, Parker operates and continues to invest in our manufacturing facilities in Europe, North America and Asia.

Electromechanical Worldwide Manufacturing Locations

Europe

Littlehampton, United Kingdom
Dijon, France
Offenburg, Germany
Filderstadt, Germany
Milan, Italy

Asia

Wuxi, China
Chennai, India

North America

Rohnert Park, California
Irwin, Pennsylvania
Charlotte, North Carolina
New Ulm, Minnesota



Offenburg, Germany

Local Manufacturing and Support in Europe

Parker provides sales assistance and local technical support through a network of dedicated sales teams and authorized technical distributors throughout Europe.

For contact information, please refer to the Sales Offices on the back cover of this document or visit www.parker.com



Milan, Italy



Littlehampton, UK



Filderstadt, Germany



Dijon, France

Variable Speed Drive - AC10 Series

Overview

Description

The AC10 Compact Drive is a simple, reliable and economical solution to every-day motor control applications requiring speed or torque control within the power range of 0.2 kW to 180 kW for IP20 and 0.4 kW to 15 kW for IP66. Having compact dimensions and features normally only associated with higher specification drives, including, sensorless vector mode for control of Permanent Magnet (PMAC) and AC induction motors, output frequency up to 590 Hz, 3 phase 400 V supplies in all 11 frame sizes and a full 150 % overload at 0.5 Hz for 1 minute, AC10 provides an optimised solution for OEM machine builders looking for a compact, cost-effective drive without compromising on performance.

Features

Simplicity

AC10 is designed to reduce the time and effort required to install, setup and commission through its easy to use integrated keypad. Minimal wiring requirements and two easily accessed terminal rails make AC10 fast and simple to install, having you up and running in no time at all. Auto-tuning sensorless vector mode takes AC10 beyond simple V/Hz control allowing users requiring greater dynamic speed or torque control for their application to benefit from the drives enhanced 0.5 % speed and 5 % torque accuracy.

Reliability

Proven technology and manufacturing techniques ensure AC10 has been engineered and built to deliver consistently outstanding levels of performance day in, day out ensuring maximum uptime and productivity. Thanks to its conformally coated PCBs, AC10 is able to withstand even the most arduous class 3C3 environment which many other drives in this class would struggle with, allowing you to operate AC10 with the utmost confidence in more applications.



Technical Characteristics IP20 - Overview

Power Supply	220 ... 240 VAC ±15 % Single Phase 220 ... 240 VAC ±15 % Three Phase 380 ... 480 VAC +10 % -15 % Three Phase
Input Frequency	50/60 Hz
Power Range	0.2...180 kW
Operating Temperature	0...40 °C
Analogue Inputs	1x (0-10V), 1x (0-10V, 0-5V, 0-20mA, 4-20mA)
Analogue Outputs	1x (0-10 V, 0-20 mA) frames 1-5 2x (0-10 V, 0-20 mA) frames 6-11
Digital Inputs	5x 24 VDC frames 1-5, 8x 24 VDC frames 6-11
Digital Outputs	1x 24 VDC frames 1-5 2x 24 VDC frames 6-11
Relay Output	1x 5 A @230 VAC



Technical Characteristics IP66 - Overview

Power Supply	220 ... 240 VAC ±15 % Single Phase 220 ... 240 VAC ±15 % Three Phase 380 ... 480 VAC +10 % -15 % Three Phase
Input Frequency	50/60 Hz
Power Range	0.4...15 kW
Operating Temperature	0...50 °C
Analogue Inputs	1x (0-10V), 1x (0-10V, 0-5V, 0-20mA, 4-20mA)
Analogue Outputs	1x (0-10 V, 0-20 mA)
Digital Inputs	6x 24 VDC
Digital Outputs	1x 24 VDC
Relay Output	1x 5 A @230 VAC

AC10 IP20

IE2 Efficiency MR Series AC Induction Motors

An ideal complement to AC10, the MR Series AC Induction motors are IE2 efficient and start from a power range of 0.09 kW. Featuring optional axial in-line force ventilation fan and holding brake, the MR motor is a high quality durable AC motor which when matched to the AC10 will provide you with a complete motor/drive package that will deliver optimal performance in your application.



AC10 Drives Range

One of the smallest compact-drives available and with 11 different frame sizes covering a power range of 0.2 kW through to 180 kW, AC10 is a low-cost, compact solution for simple AC induction motor control in a wide range of applications across a host of different industries.



Flexible I/O

- Freely assignable digital inputs and outputs, and relay output to suit your application needs
- Analogue inputs & outputs for connection to speed potentiometers and panel meters
- Internal dynamic brake switch as standard



Modbus/RS485 communication

- Connection to Parker PDB drive setup and monitoring tool
- Connection to PLC or other Modbus RTU / RS485 network
- Clone module connection



Extra power when it's needed

- 150 % overload for 60 seconds at 0.5 Hz to provide extra starting torque for shifting high inertia loads
- Output power can be uprated for operation in lower ambient temperatures

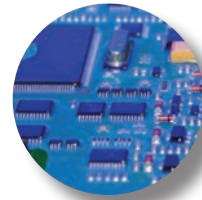

Suited to all environments

- Optional Internal EMC filter allows use in C3 industrial environments
- Conformal coating provides protection in arduous class 3C3 environments
- Global availability and support
- 50 °C operating temperature
- Fan-cooled heatsink, convection cooled electronics

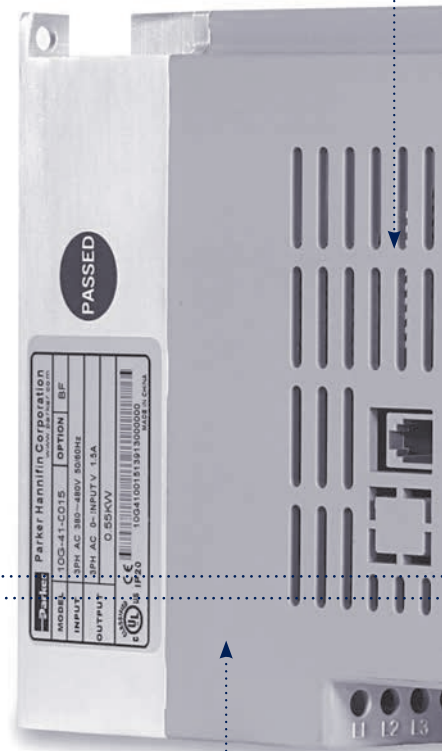



Simple or enhanced performance

- Simple V/Hz control for general energy saving applications
- Enhanced auto-tuning sensorless vector control providing higher dynamic performance for applications requiring greater speed or torque accuracy
- Sensorless PMAC & AC Induction Motor control



All at the touch of a button

- Standard ergonomic keypad providing full access to all drive functions
- 4 LEDs provide instant indication of drive status
- Remote mountable keypad option for ease of setup and operation



Simplified Setup

- Simple out of the box operation thanks to integrated macros and quick start guide
- Basic speed control
- Speed preset
- Raise / Lower
- Auto / Man
- PID control
- Essential services (Fire Mode)
- Catch a spinning load (Fly-Catching)



High Speed Operation

- Up to 590 Hz output for high speed operations such as spindles, centrifuges, mixers etc.

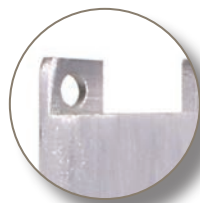

Compact Dimensions

- When compared to other compact drives of similar functionality, AC10 is noticeably more compact reducing cabinet space and freeing up valuable floor space.

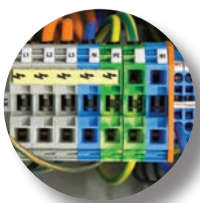

Choice of operating voltages

- 230 V single and three phase input up to 2.2 kW
- 400 V three phase input from 0.2 kW through to 180 kW
- Internal DC link choke from 30 kW removing the need for external line reactor



Control at your fingertips

AC10 comes complete with an ergonomic operator keypad as standard featuring 4 LED drive status indicators, a 4 digit 7 segment LED display and a tactile membrane style keypad.

In addition to displaying status and running information, the LED display is also used to access drive configuration parameters which can be quickly and easily changed via the keypad.

The keypad can also be used to take local control of the motor to start, stop, increase or decrease motor speed.

An optional keypad is also available and can be mounted remotely from the drive.

Sensorless Permanent Magnet (PMAC) Motor Control

AC10 is capable of providing control of any sensorless PMAC motor, such as the Parker NX series. Servo motor technology can deliver up to 10 % more energy savings than conventional induction motors and can also be up to 75 % smaller in size.



AC10 IP66

IP66 / NEMA 4x apply to IEC standard 60529-2004 and assess the capability of an enclosure to resist specific environmental conditions. Parker AC10 IP66 offers all the great benefits of the AC10 series drives but with added environmental protection, validated by the IEC, to allow operation in difficult conditions.



Applications

AC10 IP66 provides a no-fuss approach to general purpose industrial motor control applications across a wide range of industries.

The IP66 enclosure enables use in both indoor and outdoor applications where environmental conditions may be a concern, such as wash-down areas in food and beverage facilities and use in waste plants or rooftop units.

For outdoor applications the drive should be installed under a suitable cover to provide protection against potential damage caused by direct exposure to sun, ice and snow.

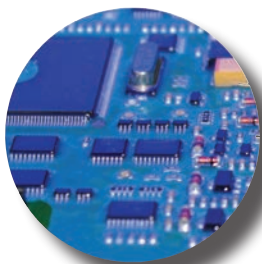

Suited to all environments

- Robust IP66 rated enclosure for environmental protection
- Optional Internal EMC filter allows use in C3 industrial environments
- Conformal coating provides protection in arduous class 3C3 environments
- 50 °C operating temperature

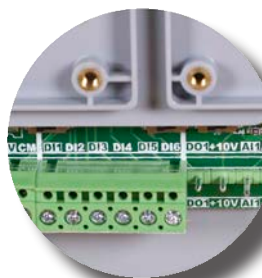

Flexible Connections

- Freely assignable digital inputs and outputs, and relay output to suit your application needs
- Internal dynamic brake switch as standard
- Connection to PLC or other Modbus RTU / RS485 network
- Clone module connection



Easy Connection Access

- Easy user access to connections with removable gland plate



Extra power when

- 150 % overload for 0.5 Hz to provide extra torque for shifting high inertia loads
- Output power can be reduced for operation in lower ambient temperatures



When it's needed
60 seconds at
extra starting torque
inertia loads
can be upgraded for
higher ambient temperatures



All at the touch of a button

- Standard ergonomic keypad providing full access to all drive functions
- Simple out of the box operation thanks to integrated macros and quick start guide



High Speed Operation

- Up to 590 Hz output for high speed operations such as spindles, centrifuges, mixers etc.



Customisation Options

- User customisable option panel for:
 - Isolators
 - Switches
 - Push buttons
 - Indicators

Energy savings made simple

For applications such as fan control, energy savings of up to 50% can be achieved by using the AC10 IP66 to match the motor speed to process requirements.

In addition to saving energy, power factor can be improved, system noise reduced, maintenance periods extended and overall service life increased.

AC10 IP66 can be integrated close to the motor, regardless of the environmental conditions, saving in cabling costs, space and energy as well as the cost of separate cabinets.

Dependent upon the application, payback time can be as little as a few months.

Decentralisation

AC10 IP66 enables the decentralised drive system where the drives should be installed as close as possible to the motor it is running. Savings can be achieved through reductions in cable installation times as well as the cost of the cabling itself.

Because the drive is self-enclosed no cabinets are required to hold them, saving space and money. Self-enclosure also means that heat output from the drives does not need to be ventilated from the cabinet, leading to a system which is simpler and easier to maintain.

Applications

AC10 provides a no-fuss approach to general purpose industrial motor control applications across a wide range of industries, giving users the benefits of the inherent energy-saving properties of using a variable speed drive, as well as the improved reliability and extended service life benefits associated with smoother starting and stopping of regularly cycling loads.

Typical applications for AC10 include...

- Conveyor
- Centrifuge
- Fans
- Mixers
- Packaging Machines
- Textile Machines
- Strapping Machines
- Labelling Machines
- Industrial Washing Machines
- Machine Tool Spindles
- Roller Doors



Conveyors

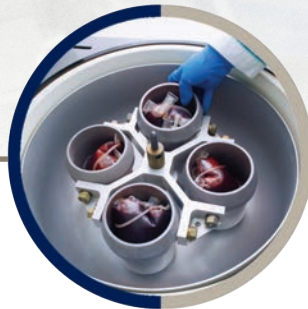

Centrifuges



Fans



Mixers

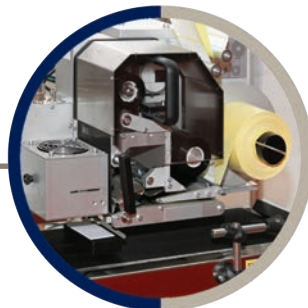

Packaging Machines

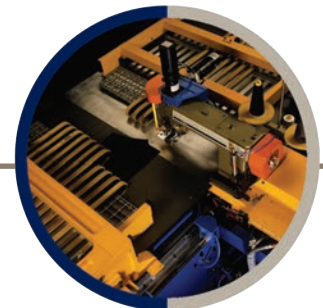

Textile Machines

Technical Characteristics

Power Ratings IP20

230 V Single Phase Input / 230 V Three phase Input		
Nominal Power [kW]	Output Current [A]	Frame Size
0.2	1.5	1
0.4	2.5	1
0.55	3.5	1
0.75	4.5	1
1.1	5	2
1.5	7	2
2.2	10	2

400 V Three phase Input		
Nominal Power [kW]	Output Current [A]	Frame Size
0.2	0.6	1
0.4	1	1
0.55	1.5	1
0.75	2	2
1.1	3	2
1.5	4	2
2.2	6.5	2
3	8	3
4	9	3
5.5	12	3
7.5	17	4
11	23	4
15	32	5
18.5	38	5
22	44	5
30	60	6
37	75	7
45	90	7
55	110	8
75	150	8
90	180	9
110	220	9
132	265	10
160	320	11
180	360	11

Technical Characteristics

Power Ratings IP66

220 V Single Phase Input / 230 V Three phase Input		
Nominal Power [kW]	Output Current [A]	Frame Size
0.4	2.5	1
0.75	4.5	1
1.5	7	1
2.2	10	1

400 V Three phase Input		
Nominal Power [kW]	Output Current [A]	Frame Size
0.75	2	1
1.5	4	1
3	7	1
4	9	1
5.5	12	2
7.5	17	2
11	23	3
15	32	3

Electrical Characteristics

Power Supply	220 ... 240 VAC $\pm 15\%$ Single Phase 220 ... 240 VAC $\pm 15\%$ Three Phase 380 ... 480 VAC $+10\%$ -15% Three Phase
Rated Input Frequency	50/60 Hz
Maximum Switching Frequency	10 kHz without derating
Overload	150% of Rated Current for 60s, 200% for 2s
Output Frequency	0.5...590 Hz
Switching Frequency	2...10kHz selectable
Control Mode	Volts/Hertz or Sensorless Vector (SLV) Mode
Earth Leakage Current	>10 mA (all models)

Environmental Characteristics

Temperature range	Operating Temperature: 0...+50 °C (derate above 40 °C, IP20 only)
Humidity	Operating humidity: Below 90 % Relative Humidity, non-condensing
Vibration	Below 0.5 g
Altitude	1000 m ASL
Protection Degree	IP20 & IP66
Chemically Active Substances	For the standard product, compliance with EN60271-3-3 is Class 3C3

Standards and Compliance

European Certification	This product conforms with the Low Voltage Directive 2006/95/EC and Electro-Magnet Compatibility Directive 2004/108/EC. Compliant with European Standards EN 61800-5-1:2007 and EN 61800-3:2004+A1:2012 "Adjustable speed electrical power drive systems"
North American	PENDING: Complies with the NEC NFPA 70, Underwriters Laboratories (UL) Listed to UL508C
Canada	PENDING: Complies with the Canadian Electrical Code, Underwriters Laboratories (UL) Listed to CSA 22.2 No. 14

Dimensions IP20 - Frames 1-5

AC10				
Frame	Height (H)	Width (W)	Depth (D)	Weight [kg]
1	138	80	135	1.25
2	180	106	150	1.76
3	235	138	152	2.96
4	265	156	170	4.9
5	340	205	196	7.5

Dimensions [mm]

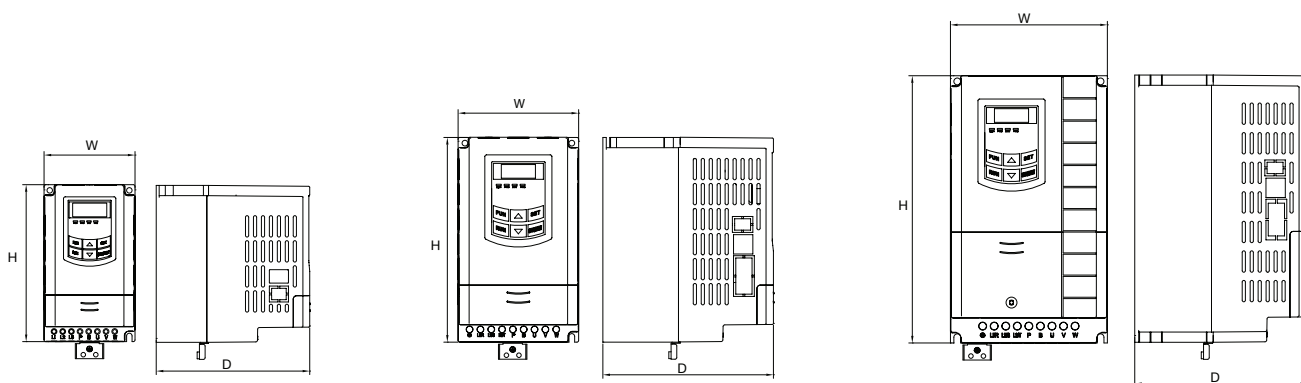

Frame 1

Frame 2

Frame 3

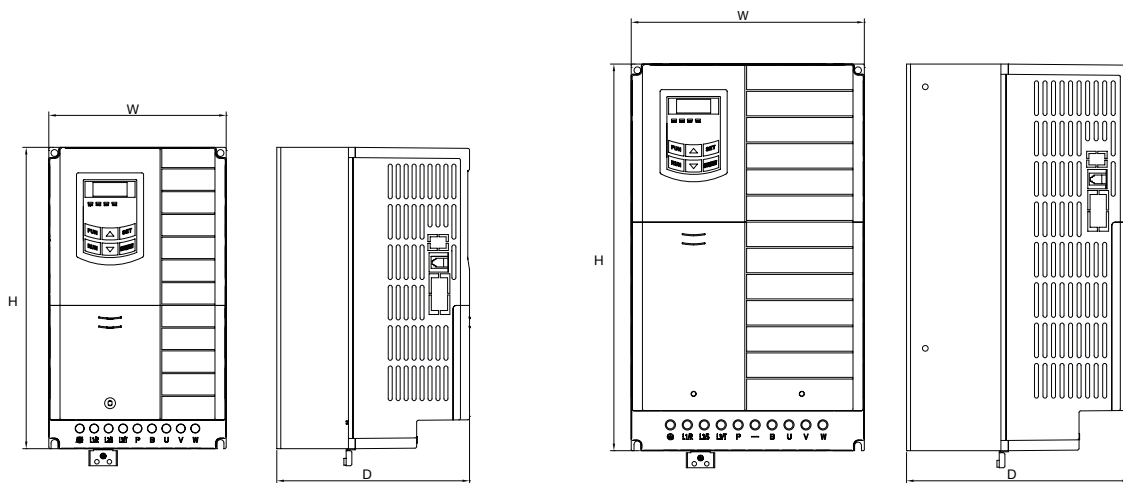

Frame 4

Frame 5

Dimensions IP20 - Frames 6-11

AC10				
Frame	Height (H)	Width (W)	Depth (D)	Weight [kg]
6	435	265	235	17
7	480	315	234	25
8	555	360	265	40
9	630	410	300	55
10	765	516	326	94
11	910	560	342	120

Dimensions [mm]

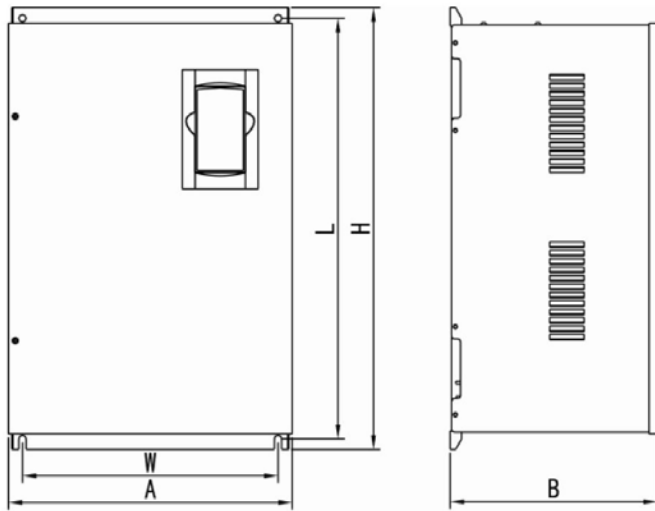

Frames 6-11

Dimensions IP66

Frame	Height (H)	Width (W)	Depth (D)
1	412	200	198
2	418	242	198
3	471	242	228

Dimensions [mm]

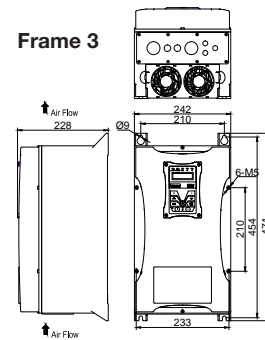
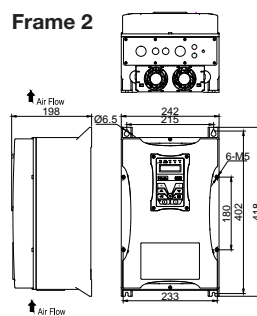
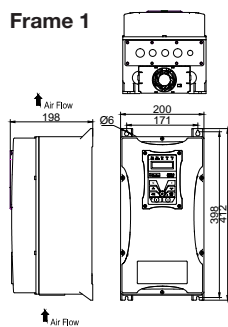

Connections

Terminal	Description
L1/R	Single or three phase input L1
L2/S	Single or three phase input L2
L3/T	Three phase input L3
P	Braking Resistor
B	Braking Resistor
U	Motor Output 1/U
V	Motor Output 2/V
W	Motor Output 3/W

Terminal	Description
TA	Alarm N/O Relay Contact 5 A 24 VDC
TB	Alarm N/C Relay Contact 5 A 24 VDC
TC	Drive Alarm Common
DO1	Digital Output 1
DO2	Digital Output 2 (Frames 6-11 only)
24V	24 VDC Digital Output (max 50 mA)
CM	0 V DC Common
DI1	Digital Input 1
DI2	Digital Input 2
DI3	Digital Input 3
DI4	Digital Input 4
DI5	Digital Input 5
DI6	Digital Input 6 (IP66 & Frames 6-11 only)
DI7	Digital Input 7 (Frames 6-11 only)
DI8	Digital Input 8 (Frames 6-11 only)
10V	10 V Reference supply (max 20 mA)
AI1	Analogue input 1
AI2	Analogue input 2
GND	Power Supply 0 V
AO1	Analogue Output 1
AO2	Analogue Output 2
A+	RS485 Channel A
B-	RS485 Channel B

- Analogue Input 1: (0-10V)
- Analogue Input 2: (0-10V, 0-5V, 0-20mA, 4-20mA)
- Analogue Outputs: (0-10 V, 0-20 mA)
- Digital Inputs: Nominal 24 VDC
- Digital Outputs: Nominal 24 VDC
- Relay Output 1: Volt free contact, 5 A @230 VAC max.

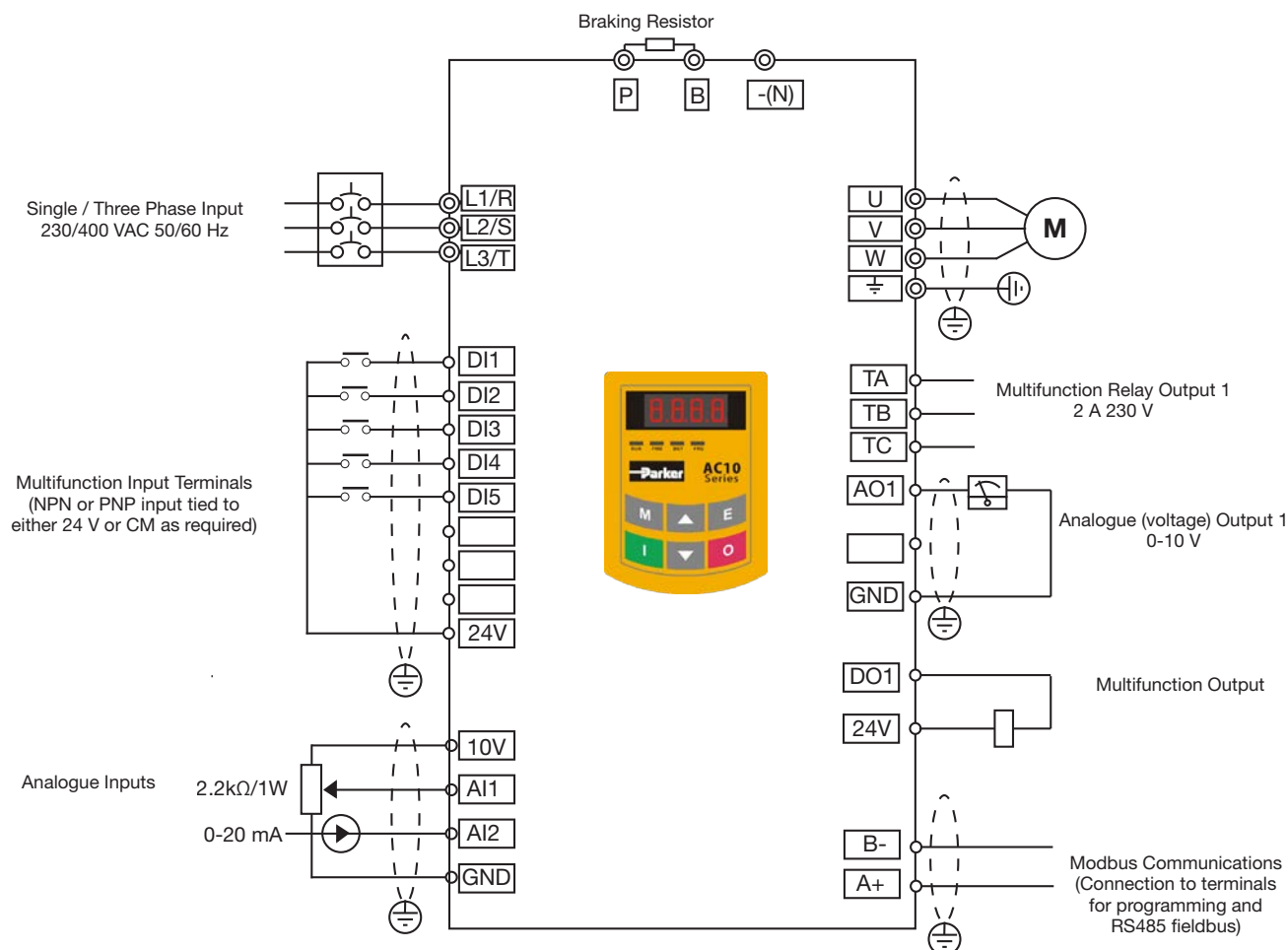

Accessories and Options

Remote Mounting Keypad

The remote mounting keypad (IP20 only) allows users to mount the keypad away from the drive, such as on the door of an electrical enclosure, allows users to configure, operate and monitor the drive without having to access the drive directly.

The remote keypad provides the same functionality as the drive mounted keypad and is connected to the drive via a 1.5 m cable plugged into the port on the left hand side of the drive.



Order Code	Description
1001-00-00	Remote Keypad

Software - Parker Drive Basic (PDB)

Free Configuration and Diagnostic Monitoring Software

Parker Drive Basic is a monitoring and configuration software tool for use with AC10 Variable Speed Drives. Parker Drive Basic is available as a free download from the Parker website.

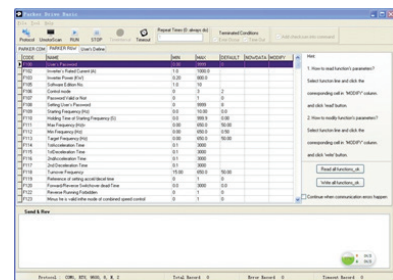

Connecting to the AC10 over Modbus, Parker Drive Basic enables users to import, modify and export drive parameters as well as providing a convenient means of starting, stopping and monitoring the operation of the drive.

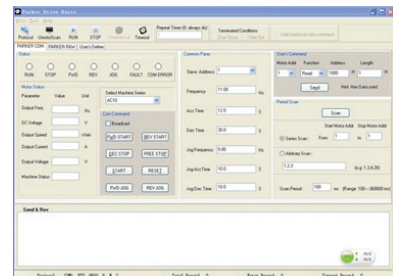

Note: a USB/RS485 adapter is required to enable connection between PC and drive

Clone Module

AC10 clone module allows users to copy applications between drives and upload / download parameter sets between drives and the PDB PC software.

- Extract parameters from the drive
- Download parameters to a drive
- Connect AC10 to PDB
- Copy parameters between drives

Order Code	Description
1002-00-00	Clone Module



Braking Resistor

During deceleration, or with an over-hauling load, the motor acts as a generator. Energy flows back from the motor into the DC link capacitors within the drive, causing their voltage to rise. If this voltage exceeds a maximum value, the drive will trip to protect the capacitors and internal power devices. The amount of energy that can be absorbed by the capacitors can vary between different applications causing the drive to trip on overvolts. To increase the drive's dynamic braking capability, high power resistor(s), connected across the DC link, allow the dissipation of this excess energy for short term stoppage or braking.



Brake resistor selection

Brake resistor assemblies must be rated to absorb both peak braking power during deceleration and the average power over the complete cycle.

$$\text{Peak braking power} = \frac{0.0055J \times (n_1^2 - n_2^2) (W)}{t_b}$$

$$\text{Average braking power } P_{av} = \frac{P_{pk} \times t_b}{t_c}$$

J: total inertia [kgm²]
n₁: initial speed [min⁻¹]
n₂: final speed [min⁻¹]
t_b: braking time [s]
t_c: cycle time [s]

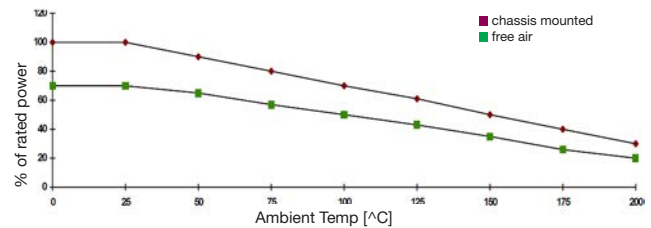

Resistors above 500 W

Resistors above 500 W are available upon request :





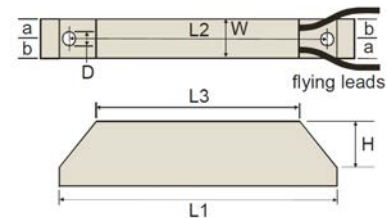

















- IP20 protection up to 3 kW
- IP13 protection between 4.2 and 9.8 kW

Model	Impedance [Ω]	Nom. Power [W]	Dimensions [mm]							
			L1	L2	L3	W	H	D	a	b
CZ467715	500	60	100	87	60	22	41	4.3	10	12
CZ467714	200	100	165	152	125	22	41	4.3	10	12
CZ389853	100	100	165	152	125	22	41	4.3	10	12
CZ467717	100	200	165	146	125	30	60	4.3	13	17
CZ463068	56	200	165	146	125	30	60	4.3	13	17
CZ388397	56	200	165	146	125	30	60	4.3	13	17
CZ388396	36	500	335	316	295	30	60	4.3	13	17
CZ467716	28 x 2	500	335	316	295	30	60	4.3	13	17

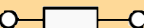
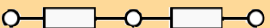
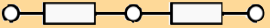

Overload 5 s: 500 %
Overload 3 s : 833 %
Overload 1 s: 2500 %

Variable Speed Drive - AC10
Accessories and Options

Power Rating [kW]	R1 Resistor Order Code	R2 Resistor Order Code	Connected	Minimum resistance [Ω]	Braking Power [W]
230 V Single Phase					
0,2	CZ467717	-		60	150
0,37	CZ467717	-		60	150
0,55	CZ467717	-		60	150
0,75	CZ467717	-		60	150
1,1	CZ467717	-		60	150
1,5	CZ467717	-		60	150
2,2	CZ467717	-		60	150
230 V Three Phase					
0,37	CZ467717	-		60	150
0,55	CZ467717	-		60	150
0,75	CZ467717	-		60	150
1,1	CZ467717	-		60	150
1,5	CZ467717	-		60	150
2,2	CZ467717	-		60	150
400 V Three Phase					
0,2	CZ467715	-		500	80
0,37	CZ467715	-		500	80
0,55	CZ467715	-		500	80
0,75	CZ467714	-		200	80
1,1	CZ467714	-		150	80
1,5	CZ467714	-		150	80
2,2	CZ467714	-		150	150
3	CZ467714	-		150	150
4	CZ467714	-		150	150
5,5	CZ467716	CZ467716		120	250
7,5	CZ388396	CZ388396		120	500
11	CZ467716	CZ467716		90	1000

Note 1: The above resistors are only provided as a guide. Please use our calculation guide to confirm accurate braking resistor requirements.

Note 2: For resistor sizes between 15 kW and 180 kW please contact ssdedcs@parker.com

Output Choke

To reduce capacitive currents and prevent nuisance tripping in installations with longer cable runs, a choke may be fitted to the drives output in series with the motor.

Order Code	Motor Power Normal Duty [kW]	Choke Inductance [mH]	Current [A_{rms}]
CO055931	1.1	2	7.5
	1.5		
	2.2		
	3.0		
CO057283	4.0	0.9	22
	5.5		
	7.5		
CO057284	11	0.45	33
	15		
CO057285	18	0.3	44
CO055193	22	50	70
	30		
CO055253	37	50	99
	45		
CO057960	55	50	243
CO0387866	75	50	360



Note 1: For output chokes over 75 kW please contact ssdedcs@parker.com

EMC Filter

A range of custom designed optional EMC (Electromagnetic Compatibility) filters are available for use with AC10. They are used to help achieve conformance with EMC directive BS EN61800-3.

AC10 can be ordered with an EMC filter fitted that meets the requirements of a class C3 environment. For class C2 or C1 environments, please contact your local sales office.

Order Code

AC10 IP20

	1	2		3	4		5		6	7
Order example	10	G	-	1	1	-	0015	-	B	N

1	Device Family	
10	AC10 IP20 Variable Speed Drive	
2	Industry	
G	General Purpose	
3	Voltage	
1	230 V Single Phase	
3	230 V Three Phase	
4	400 V Three Phase	
4&5	Frame Size & Rating	
230 V Supply		
1	0015	0.2 kW
1	0025	0.37 kW
1	0035	0.55 kW
1	0045	0.75 kW
2	0050	1.1 kW
2	0070	1.5 kW
2	0100	2.2 kW
400 V Supply		
1	0006	0.2 kW
1	0010	0.37 kW
1	0015	0.55 kW
2	0020	0.75 kW
2	0030	1.1 kW
2	0040	1.5 kW
2	0065	2.2 kW
3	0080	3.0 kW
3	0090	4.0 kW
3	0120	5.5 kW
4	0170	7.5 kW
4	0230	11 kW
5	0320	15 kW
5	0380	18.5 kW
5	0440	22 kW
6	0600	30 kW
7	0750	37 kW
7	0900	45 kW
8	1100	55 kW
8	1500	75 kW
9	1800	90 kW
9	2200	110 kW
10	2650	132 kW
11	3200	160 kW
11	3600	180 kW
6	Braking Module	
B	Braking Module Fitted	
7	EMC Filter	
N	No Filter Fitted	
F	C3 EMC Filter Fitted	

Visit the Parker website to full configure the options available for AC10, generate the correct product code and to find out where to buy.

www.parker.com/ssd/ac10

Order Code

AC10 IP66

	1	2		3	4		5		6	7
Order example	16	G	-	1	1	-	0015	-	B	N

1	Device Family	
16	AC10 IP66 Variable Speed Drive	
2	Industry	
G	General Purpose	
3	Voltage	
1	230 V Single Phase	
3	230 V Three Phase	
4	400 V Three Phase	
4&5	Frame Size & Rating	
230 V Supply		
1	0025	0.4 kW
1	0045	0.75 kW
1	0070	1.5 kW
1	0100	2.2 kW
400 V Supply		
1	0020	0.75 kW
1	0040	1.5 kW
1	0065	2.2 kW
1	0080	3.0 kW
1	0090	4.0 kW
2	0120	5.5 kW
2	0170	7.5 kW
3	0230	11 kW
3	0320	15 kW
6	Braking Module	
B	Braking Module Fitted	
7	EMC Filter	
F	C3 EMC Filter Fitted	

Visit the Paker website to full configure the options available for AC10, generate the correct product code and to find out where to buy.

www.parker.com/ssd/ac10



Parker's Motion & Control Technologies

At Parker, we're guided by a relentless drive to help our customers become more productive and achieve higher levels of profitability by engineering the best systems for their requirements. It means looking at customer applications from many angles to find new ways to create value. Whatever the motion and control technology need, Parker has the experience, breadth of product and global reach to consistently deliver. No company knows more about motion and control technology than Parker. For further info call 00800 27 27 5374



Aerospace

Key Markets

Aftermarket services
Commercial transports
Engines
General & business aviation
Helicopters
Launch vehicles
Military aircraft
Missiles
Power generation
Regional transports
Unmanned aerial vehicles

Key Products

Control systems & actuation products
Engine systems & components
Fluid conveyance systems & components
Fluid metering, delivery & atomization devices
Fuel systems & components
Fuel tank inerting systems
Hydraulic systems & components
Thermal management
Wheels & brakes



Climate Control

Key Markets

Agriculture
Air conditioning
Construction Machinery
Food & beverage
Industrial machinery
Life sciences
Oil & gas
Precision cooling
Process
Refrigeration
Transportation

Key Products

Accumulators
Advanced actuators
CO₂ controls
Electronic controllers
Filter driers
Hand shut-off valves
Heat exchangers
Hose & fittings
Pressure regulating valves
Refrigerant distributors
Safety relief valves
Smart pumps
Solenoid valves
Thermostatic expansion valves



Electromechanical

Key Markets

Aerospace
Factory automation
Life science & medical
Machine tools
Packaging machinery
Paper machinery
Plastics machinery & converting
Primary metals
Semiconductor & electronics
Textile
Wire & cable

Key Products

AC/DC drives & systems
Electric actuators, gantry robots & slides
Electrohydraulic actuation systems
Electromechanical actuation systems
Human machine interface
Linear motors
Stepper motors, servo motors, drives & controls
Structural extrusions



Filtration

Key Markets

Aerospace
Food & beverage
Industrial plant & equipment
Life sciences
Marine
Mobile equipment
Oil & gas
Power generation & renewable energy
Process
Transportation
Water Purification

Key Products

Analytical gas generators
Compressed air filters & dryers
Engine air, coolant, fuel & oil filtration systems
Fluid condition monitoring systems
Hydraulic & lubrication filters
Hydrogen, nitrogen & zero air generators
Instrumentation filters
Membrane & fiber filters
Microfiltration
Sterile air filtration
Water desalination & purification filters & systems



Fluid & Gas Handling

Key Markets

Aerial lift
Agriculture
Bulk chemical handling
Construction machinery
Food & beverage
Fuel & gas delivery
Industrial machinery
Life sciences
Marine
Mining
Mobile
Oil & gas
Renewable energy
Transportation

Key Products

Check valves
Connectors for low pressure fluid conveyance
Deep sea umbilicals
Diagnostic equipment
Hose couplings
Industrial hose
Mooring systems & power cables
PTFE hose & tubing
Quick couplings
Rubber & thermoplastic hose
Tube fittings & adapters
Tubing & plastic fittings



Hydraulics

Key Markets

Aerial lift
Agriculture
Alternative energy
Construction machinery
Forestry
Industrial machinery
Machine tools
Marine
Material handling
Mining
Oil & gas
Power generation
Refuse vehicles
Renewable energy
Truck hydraulics
Turf equipment

Key Products

Accumulators
Cartridge valves
Electrohydraulic actuators
Human machine interfaces
Hybrid drives
Hydraulic cylinders
Hydraulic motors & pumps
Hydraulic systems
Hydraulic valves & controls
Hydrostatic steering
Integrated hydraulic circuits
Power take-offs
Power units
Rotary actuators
Sensors



Pneumatics

Key Markets

Aerospace
Conveyor & material handling
Factory automation
Life science & medical
Machine tools
Packaging machinery
Transportation & automotive

Key Products

Air preparation
Brass fittings & valves
Manifolds
Pneumatic accessories
Pneumatic actuators & grippers
Pneumatic valves & controls
Quick disconnects
Rotary actuators
Rubber & thermoplastic hose & couplings
Structural extrusions
Thermoplastic tubing & fittings
Vacuum generators, cups & sensors



Process Control

Key Markets

Alternative fuels
Biopharmaceuticals
Chemical & refining
Food & beverage
Marine & shipbuilding
Medical & dental
Microelectronics
Nuclear Power
Offshore oil exploration
Oil & gas
Pharmaceuticals
Power generation
Pulp & paper
Steel
Water/wastewater

Key Products

Analytical Instruments
Analytical sample conditioning products & systems
Chemical injection fittings & valves
Fluoropolymer chemical delivery fittings, valves & pumps
High purity gas delivery fittings, valves, regulators & digital flow controllers
Industrial mass flow meters/controllers
Permanent no-weld tube fittings
Precision industrial regulators & flow controllers
Process control double block & bleeds
Process control fittings, valves, regulators & manifold valves



Sealing & Shielding

Key Markets

Aerospace
Chemical processing
Consumer
Fluid power
General Industrial
Information technology
Life sciences
Microelectronics
Military
Oil & gas
Power generation
Renewable energy
Telecommunications
Transportation

Key Products

Dynamic seals
Elastomeric o-rings
Electro-medical instrument design & assembly
EMI shielding
Extruded & precision-cut, fabricated elastomeric seals
High temperature metal seals
Homogeneous & inserted elastomeric shapes
Medical device fabrication & assembly
Metal & plastic retained composite seals
Shielded optical windows
Silicone tubing & extrusions
Thermal management
Vibration dampening

Parker Worldwide

Europe, Middle East, Africa

AE – United Arab Emirates, Dubai
Tel: +971 4 8127100
parker.me@parker.com

AT – Austria, Wiener Neustadt
Tel: +43 (0)2622 23501-0
parker.austria@parker.com

AT – Eastern Europe, Wiener Neustadt
Tel: +43 (0)2622 23501 900
parker.easteurope@parker.com

AZ – Azerbaijan, Baku
Tel: +994 50 2233 458
parker.azerbaijan@parker.com

BE/LU – Belgium, Nivelles
Tel: +32 (0)67 280 900
parker.belgium@parker.com

BG – Bulgaria, Sofia
Tel: +359 2 980 1344
parker.bulgaria@parker.com

BY – Belarus, Minsk
Tel: +375 17 209 9399
parker.belarus@parker.com

CH – Switzerland, Etoy
Tel: +41 (0)21 821 87 00
parker.switzerland@parker.com

CZ – Czech Republic, Klecany
Tel: +420 284 083 111
parker.czechrepublic@parker.com

DE – Germany, Kaarst
Tel: +49 (0)2131 4016 0
parker.germany@parker.com

DK – Denmark, Ballerup
Tel: +45 43 56 04 00
parker.denmark@parker.com

ES – Spain, Madrid
Tel: +34 902 330 001
parker.spain@parker.com

FI – Finland, Vantaa
Tel: +358 (0)20 753 2500
parker.finland@parker.com

FR – France, Contamine s/Arve
Tel: +33 (0)4 50 25 80 25
parker.france@parker.com

GR – Greece, Athens
Tel: +30 210 933 6450
parker.greece@parker.com

HU – Hungary, Budaörs
Tel: +36 23 885 470
parker.hungary@parker.com

IE – Ireland, Dublin
Tel: +353 (0)1 466 6370
parker.ireland@parker.com

IT – Italy, Corsico (MI)
Tel: +39 02 45 19 21
parker.italy@parker.com

KZ – Kazakhstan, Almaty
Tel: +7 7273 561 000
parker.easteurope@parker.com

NL – The Netherlands, Oldenzaal
Tel: +31 (0)541 585 000
parker.nl@parker.com

NO – Norway, Asker
Tel: +47 66 75 34 00
parker.norway@parker.com

PL – Poland, Warsaw
Tel: +48 (0)22 573 24 00
parker.poland@parker.com

PT – Portugal, Leca da Palmeira
Tel: +351 22 999 7360
parker.portugal@parker.com

RO – Romania, Bucharest
Tel: +40 21 252 1382
parker.romania@parker.com

RU – Russia, Moscow
Tel: +7 495 645-2156
parker.russia@parker.com

SE – Sweden, Spånga
Tel: +46 (0)8 59 79 50 00
parker.sweden@parker.com

SK – Slovakia, Banská Bystrica
Tel: +421 484 162 252
parker.slovakia@parker.com

SL – Slovenia, Novo Mesto
Tel: +386 7 337 6650
parker.slovenia@parker.com

TR – Turkey, Istanbul
Tel: +90 216 4997081
parker.turkey@parker.com

UA – Ukraine, Kiev
Tel: +380 44 494 2731
parker.ukraine@parker.com

UK – United Kingdom, Warwick
Tel: +44 (0)1926 317 878
parker.uk@parker.com

ZA – South Africa, Kempton Park
Tel: +27 (0)11 961 0700
parker.southafrica@parker.com

North America

CA – Canada, Milton, Ontario
Tel: +1 905 693 3000

US – USA, Cleveland
Tel: +1 216 896 3000

Asia Pacific

AU – Australia, Castle Hill
Tel: +61 (0)2-9634 7777

CN – China, Shanghai
Tel: +86 21 2899 5000

HK – Hong Kong
Tel: +852 2428 8008

IN – India, Mumbai
Tel: +91 22 6513 7081-85

JP – Japan, Tokyo
Tel: +81 (0)3 6408 3901

KR – South Korea, Seoul
Tel: +82 2 559 0400

MY – Malaysia, Shah Alam
Tel: +60 3 7849 0800

NZ – New Zealand, Mt Wellington
Tel: +64 9 574 1744

SG – Singapore
Tel: +65 6887 6300

TH – Thailand, Bangkok
Tel: +662 186 7000

TW – Taiwan, Taipei
Tel: +886 2 2298 8987

South America

AR – Argentina, Buenos Aires
Tel: +54 3327 44 4129

BR – Brazil, Sao Jose dos Campos
Tel: +55 800 727 5374

CL – Chile, Santiago
Tel: +56 2 623 1216

MX – Mexico, Toluca
Tel: +52 72 2275 4200



EMEA Product Information Centre

Free phone: 00 800 27 27 5374

(from AT, BE, CH, CZ, DE, DK, EE, ES, FI, FR, IE, IL, IS, IT, LU, MT, NL, NO, PL, PT, RU, SE, SK, UK, ZA)

US Product Information Centre

Toll-free number: 1-800-27 27 537

www.parker.com